

Handled by, department  
Mikael Suurkula  
Building Technology and Mechanics  
+46 10 516 50 36, Mikael.Suurkula@sp.se

Invacare Deutschland GmbH  
Kleiststrasse 49  
324 57 Porta Westfalica  
Germany

## Crash test of the Typhoon II wheelchair and Typhoon docking station according to ISO 10542

(3 appendices)

### Summary

A crash test of the Typhoon docking station for the Typhoon II electrical wheelchair has been performed according to ISO 10542-3:2005, section 6.1.

The docking station was tested in 48-50 km/h together with a Typhoon II wheelchair, 185 kg, loaded with a Hybrid III-dummy with a weight of 76 kg.

ISO 10542-1 Section		Comment	Fulfillment of requirement
6.2.1a	ATD shall be retained in the seat		Yes
6.2.1b	The wheelchair shall remain upright		Yes
6.2.1c	No detachment of anchorage components		Yes
6.2.1d	No tools required to release the wheelchair		Yes
6.2.1e	No tools required to release the ATD		Yes
6.2.1f	No visible signs of failure of load-bearing parts		Yes
6.2.1g	No sharp edges of the tiedown system		Yes
6.2.1h	Opening force < 60 N for the restraint and tiedown		Yes
6.2.2a	Horizontal excursion		Yes
6.2.2b	Knee vs. WC excursion		Yes

The test object fulfilled the requirements according to ISO 10542-3:2005, section 6.1.

### SP Technical Research Institute of Sweden

Postal address  
SP  
Box 857  
SE-501 15 Borås  
SWEDEN

Office location  
Västeråsen  
Brinellgatan 4  
SE-504 62 Borås  
SWEDEN

Phone / Fax / E-mail  
+46 10 516 50 00  
+46 33 13 55 02  
info@sp.se

Laboratories are accredited by the Swedish Board for Accreditation and Conformity Assessment (SWEDAC) under the terms of Swedish legislation. This report may not be reproduced other than in full, except with the prior written approval of the issuing laboratory.

## 1 Introduction

By commission of Invacare Deutschland GmbH a crash test of the Typhoon docking station for the Typhoon II electrical wheelchair was performed according to ISO 10542-3:2005, section 6.1. The purpose of the test was to evaluate if the Typhoon docking station fulfilled the crash test requirements together with the new Typhoon II wheelchair.

## 2 Test object

Tested product:	Typhoon docking station
Wheelchair:	Typhoon II
Weight of wheelchair:	185 kg
Restraint system:	Unwin safety belt (DI/SR) with high upper attachment (3PTF).
Test object arrival at SP:	2008-02-04
Selection of test object:	The test objects have been selected by the client without SP's assistance.

## 3 Test method and performance

Test method:	ISO 10542-3:2005, section 6.1
Test date:	2008-02-06
Test facility:	SP Building Technology and Mechanics crash laboratory in Borås.
Crash pulse:	15g during 40 ms, 20g during 15 ms, 48-50 km/h (pulse id: 2)
Pulse measurement:	Two accelerometers mounted on the sled, inv no 403201 and 403215. The graph can be found in appendix 1.
Velocity measurement:	Optical time sensors measuring the time for the sled to travel a distance of 1 meter just before impact.
Excursion measurement:	The excursion values were measured from the high-speed film by the film analysis program, TEMA, with an accuracy of $\pm 5$ mm.
Film camera:	HG 2000 High-speed camera, 1000 frames per second.
Crash test dummy:	Hybrid III, 50th percentile, 76 kg. Inv. no: 401460.
Photographs:	Photos were taken before and after the test and can be found in appendix 2.

The test object was mounted directly on the sled in a forward direction and the wheelchair was attached to the docking station. A Hybrid III-dummy, 76 kg, was positioned in the test wheelchair and restrained by an Unwin belt.

The sled was accelerated to a speed of 50.6 km/h before impact.



**Figure 1** Test setup

## 4 Test results

The test results showed in this report refer only to the tested object.

In ISO 10542-3:2005, section 6.1 the standard refers to ISO 10542-1:2001, section 6.2 for the crash test performance.

**Table 1** Post-test acceptance criteria

ISO 10542-1 Section		Comment	Requirement fulfillment
6.2.1a	The ATD shall be retained in the wheelchair.		Yes
6.2.1b	The wheelchair shall be in an upright position on the impact sled.		Yes
6.2.1c	No anchorage components or securement end fittings shall be detached or separated.		Yes
6.2.1d	Release of the wheelchair from the tiedown system shall not require the use of tools.		Yes
6.2.1e	Release of the ATD from the occupant restraint shall not require the use of tools.		Yes
6.2.1f	No part of the tiedown system shall exhibit visible signs of tearing, fragmentation, fracture or complete failure of any load-bearing part, unless such parts are intended to fail in a manner that limits the forces on the occupant.		Yes
6.2.1g	The tiedown system shall exhibit no dangerous roughness, sharp edges, or protrusions likely to increase the risk of injury to the occupant.		Yes
6.2.1h	The force required to open the buckle of any tiedown or occupant restraint components shall not exceed 60 N.		Yes

**Table 2 Dynamic performance requirements during the test**

ISO 10542-1 Section 6.2.2a	The horizontal excursion of the ATD and the wheelchair with respect to the impact sled shall not exceed the values given in this table			
	Horizontal excursion	Requirement	Result/ Comment	Requirement fulfillment
	Head forward	< 650 mm	346 mm	Yes
	Knee forward	< 375 mm	181 mm	Yes
	Wheelchair point forward	< 200 mm	53 mm	Yes
ISO 10542-1 Section 6.2.2b	The tiedown system shall prevent the wheelchair from imposing forward loads on the occupant, as indicated by the ATD knee excursion exceeding the wheelchair point P excursion by 10% or more. $X_{knee} / X_{wc}$			
	Knee vs. WC excursion $X_{knee} / X_{wc}$	> 1,1	3,4	Yes

The test object fulfilled the requirements according to ISO 10542-3:2005, section 6.1.

## 5 Accuracy of measurement

The measurement uncertainty for the deceleration pulse is less than 1.5%. Reported uncertainty corresponds to an approximate 95 % confidence interval around the measured value. The interval has been calculated in accordance with GUM (The ISO guide to the expression of uncertainty in measurements), which is normally accomplished by quadratic addition of the actual standard uncertainties and multiplication of the resulting combined standard uncertainty by the coverage factor  $k=2$ .

**SP Sveriges Tekniska Forskningsinstitut**  
**Building Technology and Mechanics - Solid Mechanics and Structures**



Klas Johansson  
Technical Manager



Mikael Suurküla  
Technical Officer

### Appendices

- Appendix 1 Deceleration graph (1 page)
- Appendix 2 Photos (6 pages)
- Appendix 3 Drawings (2 pages)

# Sled deceleration, Average pulse, CFC 60

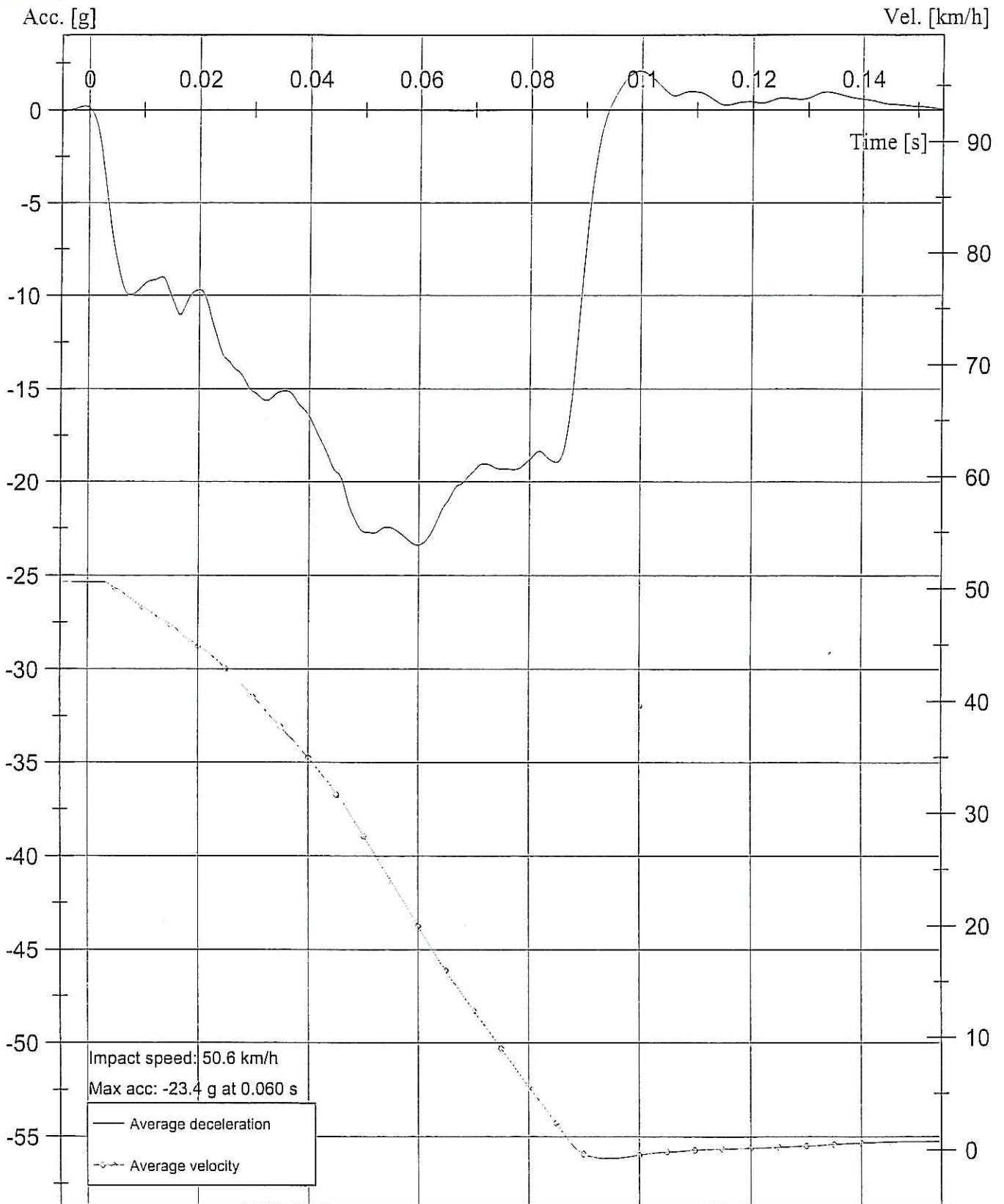

**Customer:** Invacare Germany  
**Test object:** Typhoon II with Typhoon docking station, 185 kg  
**Standard:** ISO 10542  
**Test date:** 2008-02-06      **Test:** 1

Appendix 2

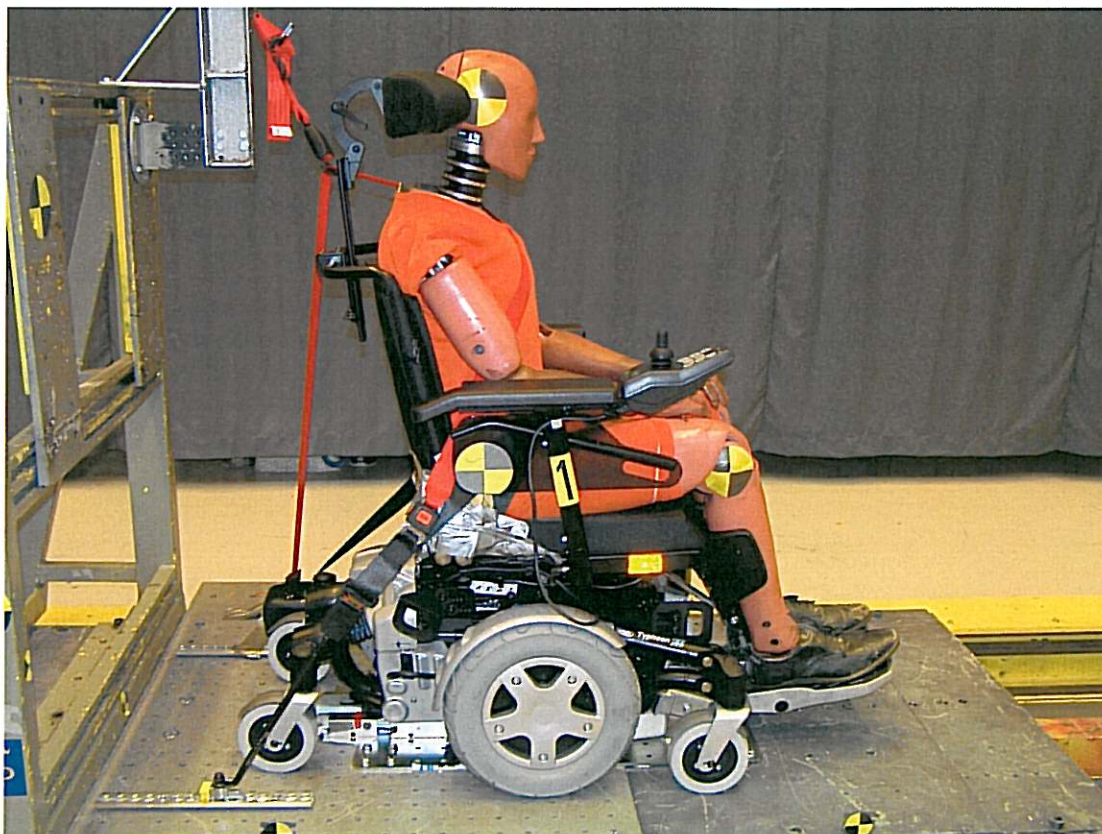

Before test 01

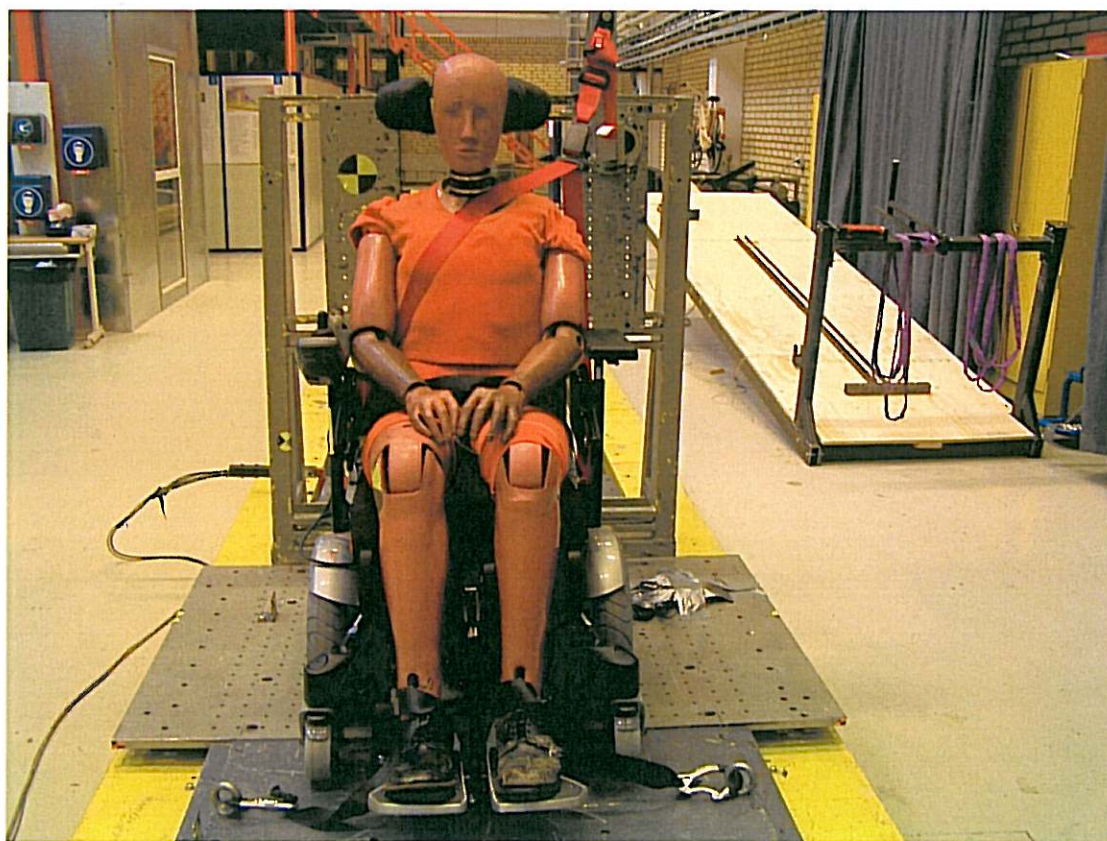

Before test 01

Appendix 2

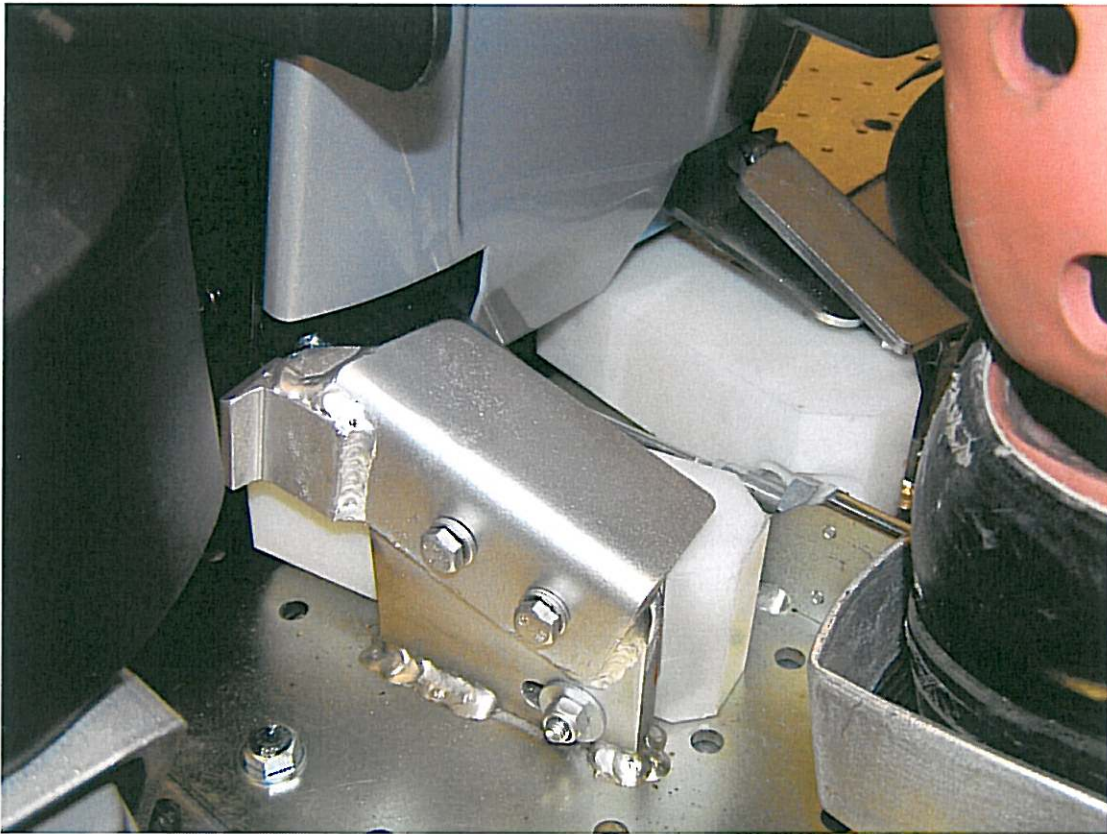

Before test 01

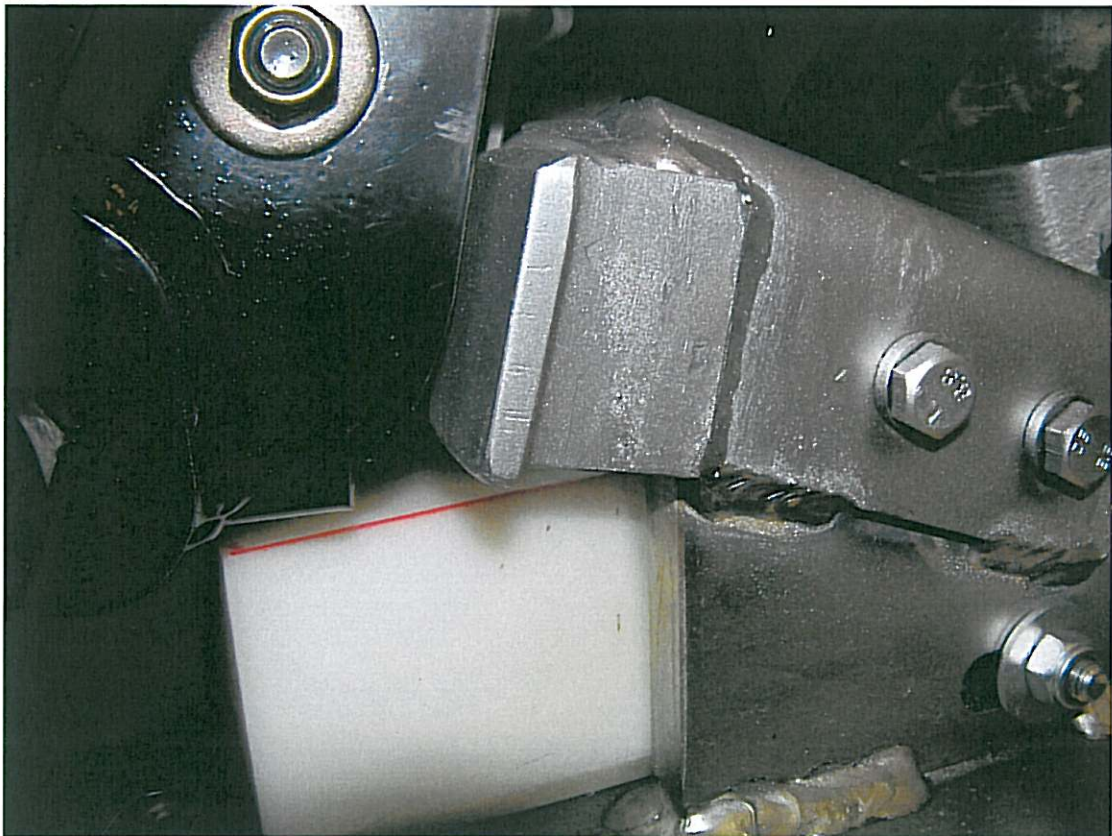

Before test 01

Appendix 2

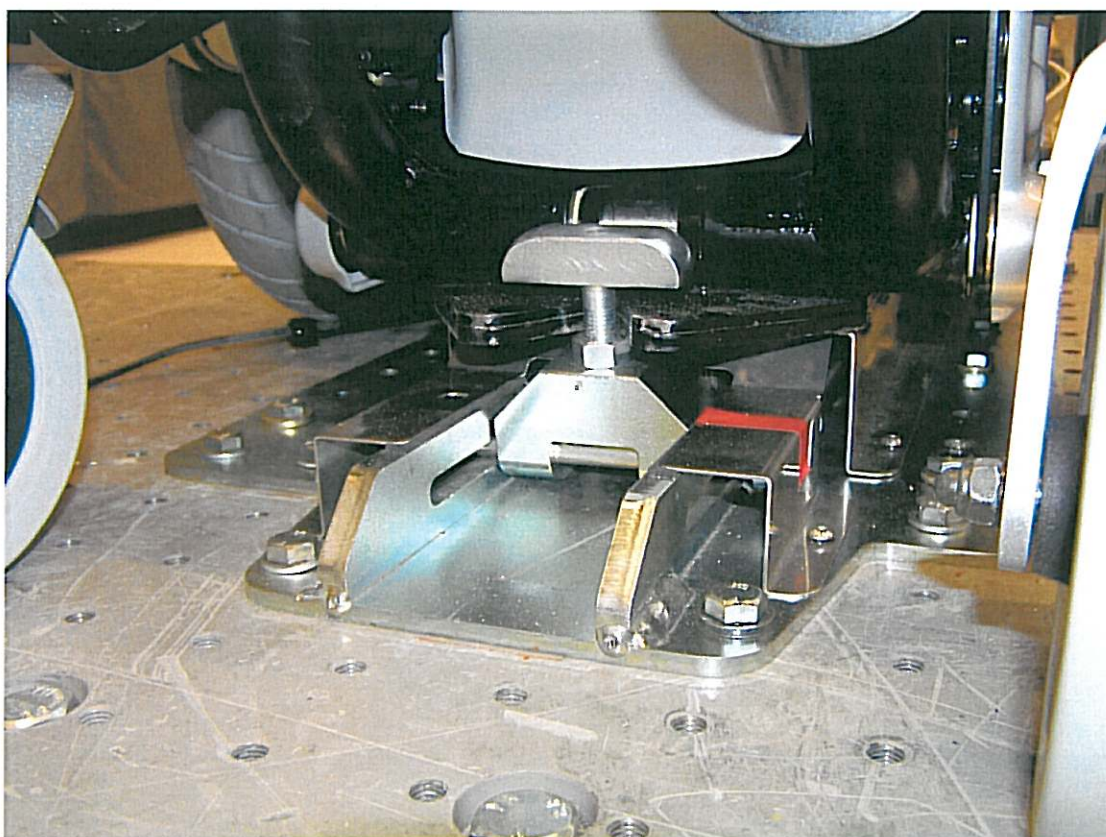

Before test 01



After test 01



Appendix 2

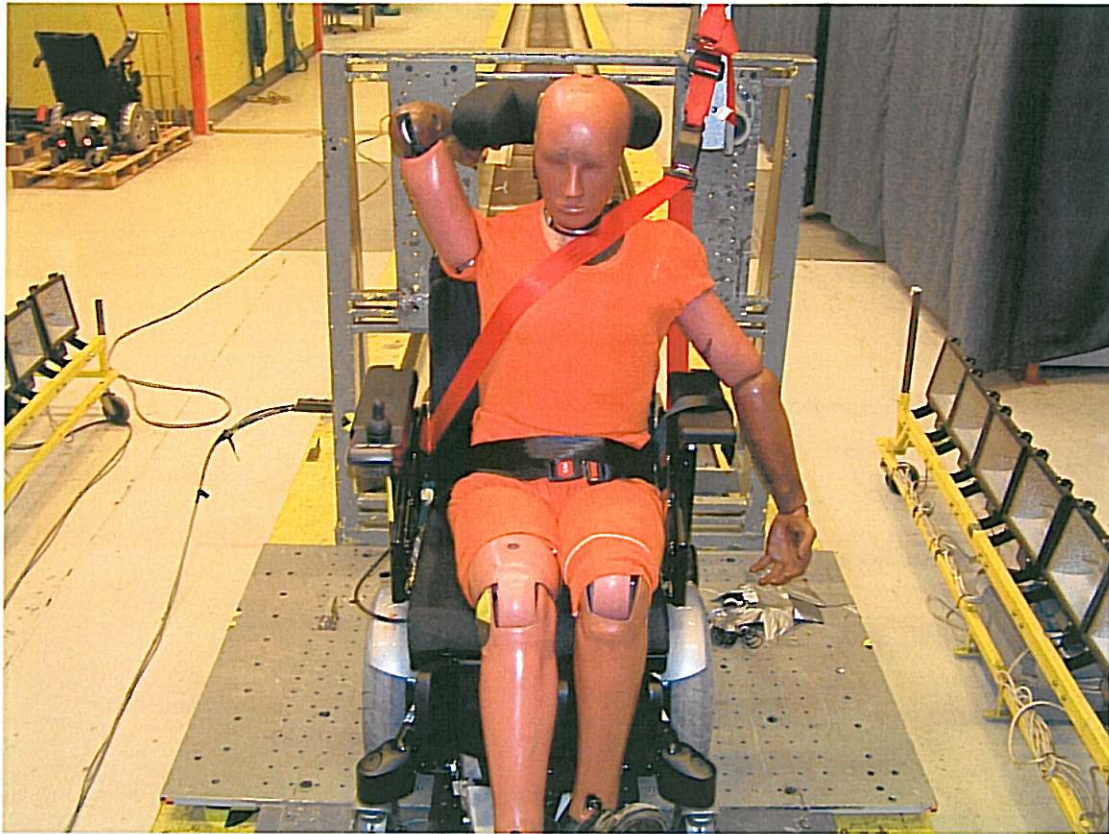

After test 01

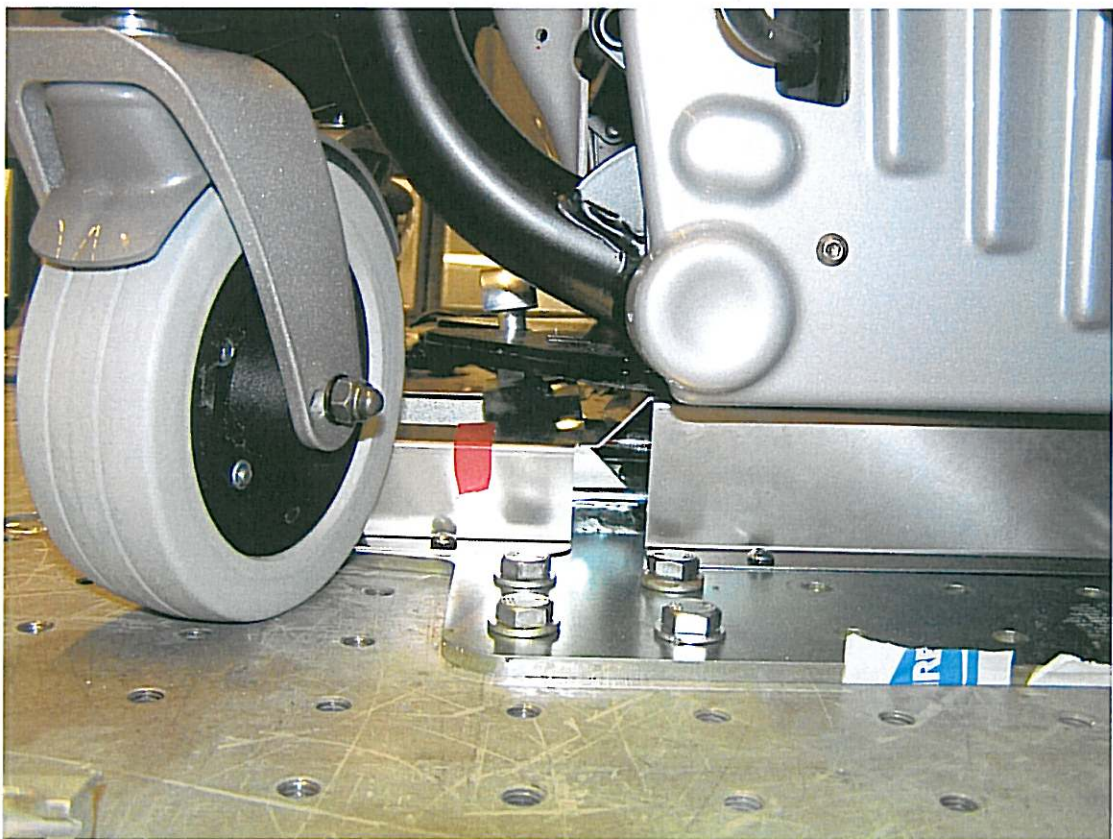

After test 01

Appendix 2

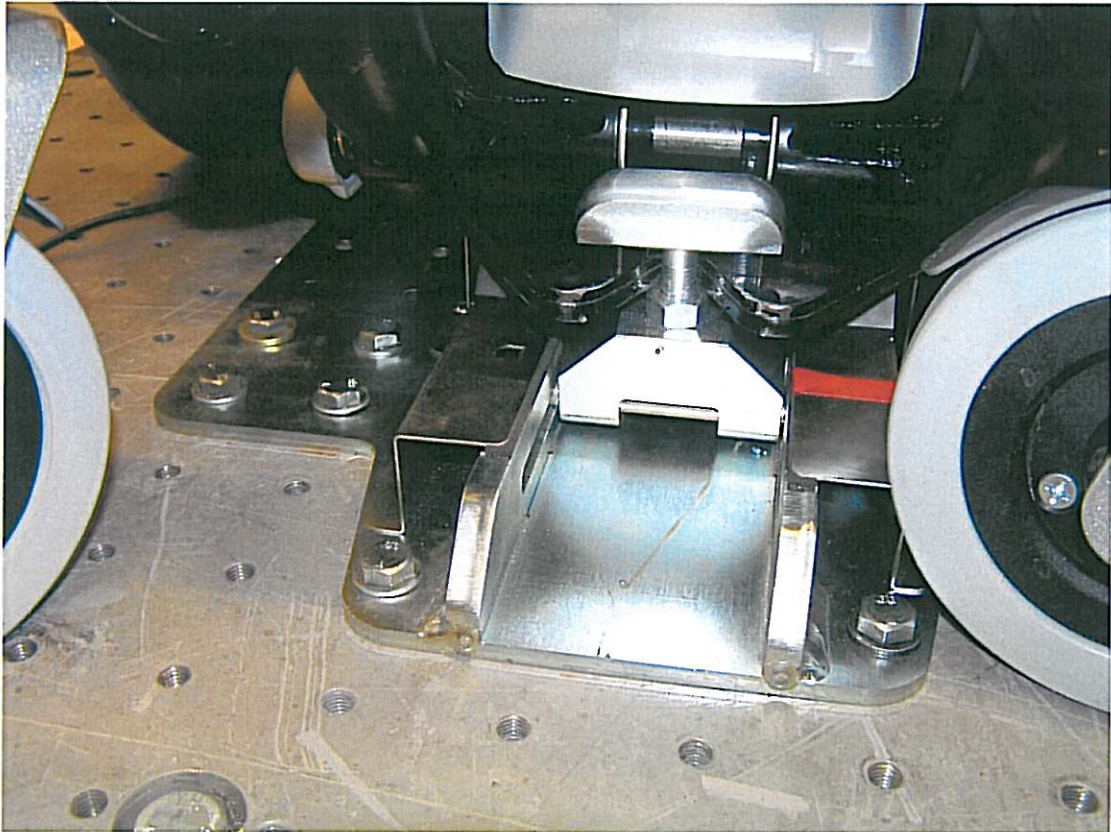

After test 01

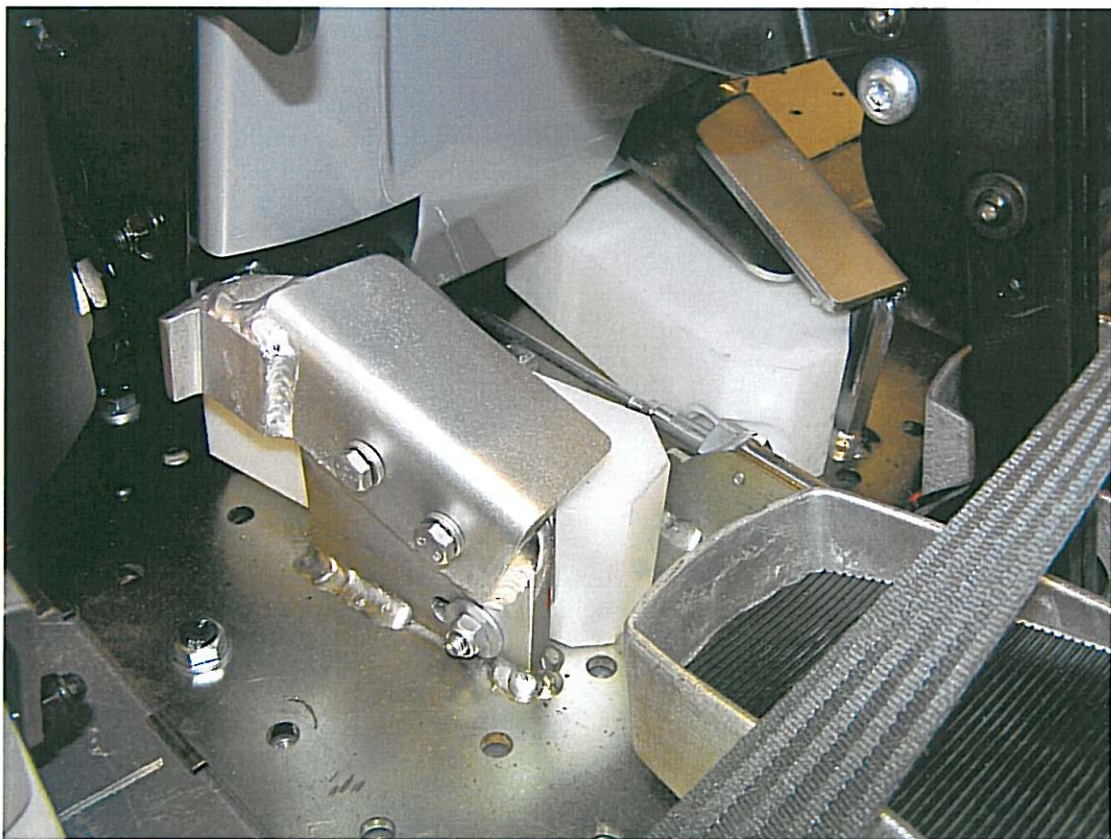

After test 01

Appendix 2

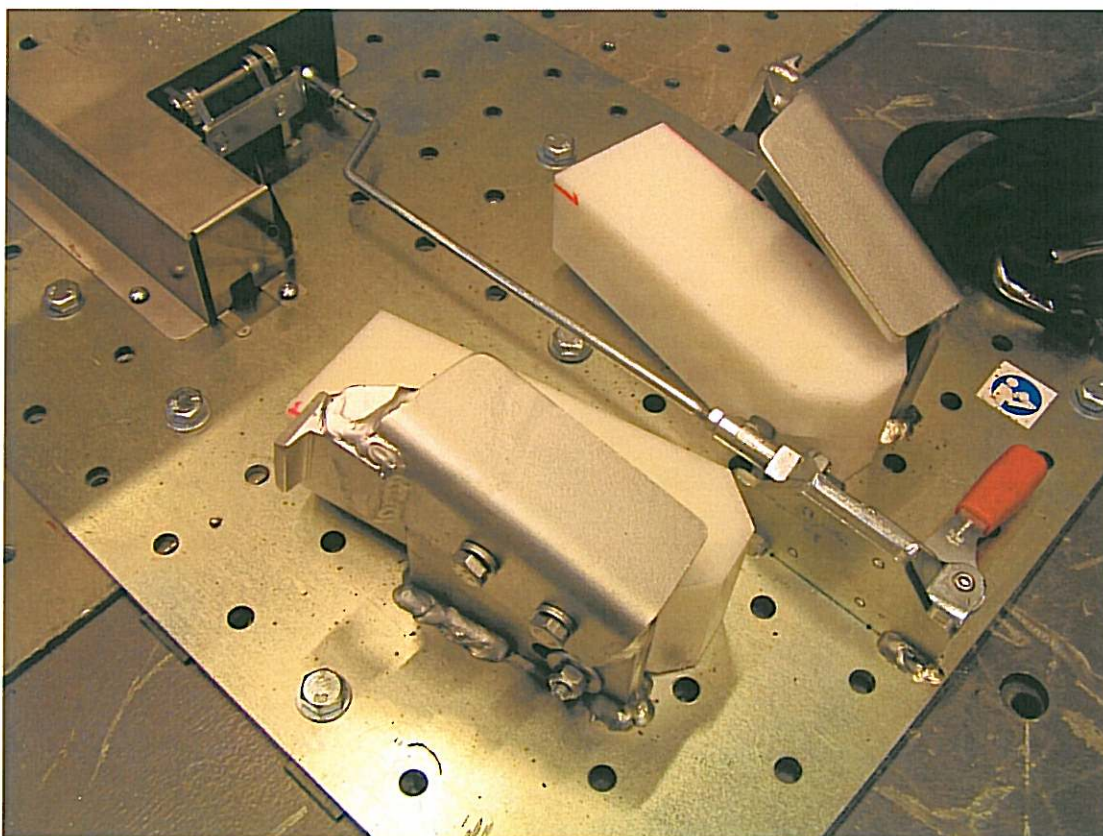

After test 01

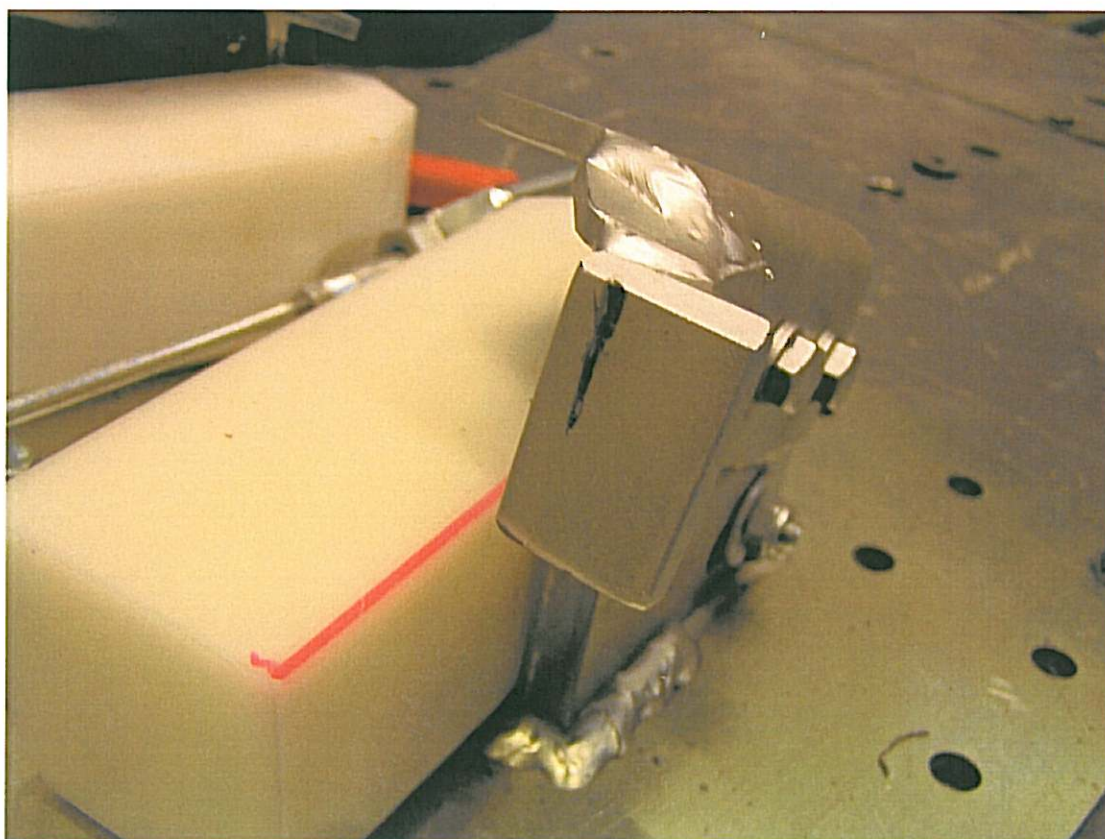

After test 01

Montagehinweise:

Suppliments für Abbruchschraube mit gesenktem Schraubenschaft  
 approximately parameters for screw screws and nuts

Größe / Size	M4	M6	M8	M10	M12	M16	M20
Abbruchschraube / Screw	1 Stk / 1 pc	1 Stk / 1 pc	1 Stk / 1 pc	1 Stk / 1 pc	1 Stk / 1 pc	1 Stk / 1 pc	1 Stk / 1 pc
Nut / Nut	1 Stk / 1 pc	1 Stk / 1 pc	1 Stk / 1 pc	1 Stk / 1 pc	1 Stk / 1 pc	1 Stk / 1 pc	1 Stk / 1 pc

von Pos. 31 bis 36 in Zeichnung nicht dargestellt  
 from pos. 31 to 36 not shown in the drawing

Pos.	Art-Nr.	Benennung	part description	Werkstoff / Stk.
------	---------	-----------	------------------	------------------

31	14.04.02	Brüchler 01	release spring	7
32	14.04.02	1 Meter 01	1 meter 01	1
33	14.04.02	Stahlblech 3mm 20 100 120 15	stainless steel 3mm 20 100 120 15	1
34	14.04.02	Handschutzhülse	hand protection	1
35	14.04.02	Handschutzhülse	hand protection	1
36	14.04.02	Handschutzhülse	hand protection	1

37	14.04.02	Handschutzhülse	hand protection	1
38	14.04.02	Handschutzhülse	hand protection	1
39	14.04.02	Handschutzhülse	hand protection	1
40	14.04.02	Handschutzhülse	hand protection	1
41	14.04.02	Handschutzhülse	hand protection	1
42	14.04.02	Handschutzhülse	hand protection	1
43	14.04.02	Handschutzhülse	hand protection	1
44	14.04.02	Handschutzhülse	hand protection	1
45	14.04.02	Handschutzhülse	hand protection	1
46	14.04.02	Handschutzhülse	hand protection	1
47	14.04.02	Handschutzhülse	hand protection	1
48	14.04.02	Handschutzhülse	hand protection	1
49	14.04.02	Handschutzhülse	hand protection	1
50	14.04.02	Handschutzhülse	hand protection	1

51	14.04.02	Handschutzhülse	hand protection	1
52	14.04.02	Handschutzhülse	hand protection	1
53	14.04.02	Handschutzhülse	hand protection	1
54	14.04.02	Handschutzhülse	hand protection	1
55	14.04.02	Handschutzhülse	hand protection	1
56	14.04.02	Handschutzhülse	hand protection	1
57	14.04.02	Handschutzhülse	hand protection	1
58	14.04.02	Handschutzhülse	hand protection	1
59	14.04.02	Handschutzhülse	hand protection	1
60	14.04.02	Handschutzhülse	hand protection	1

61	14.04.02	Handschutzhülse	hand protection	1
62	14.04.02	Handschutzhülse	hand protection	1
63	14.04.02	Handschutzhülse	hand protection	1
64	14.04.02	Handschutzhülse	hand protection	1
65	14.04.02	Handschutzhülse	hand protection	1
66	14.04.02	Handschutzhülse	hand protection	1
67	14.04.02	Handschutzhülse	hand protection	1
68	14.04.02	Handschutzhülse	hand protection	1
69	14.04.02	Handschutzhülse	hand protection	1
70	14.04.02	Handschutzhülse	hand protection	1

71	14.04.02	Handschutzhülse	hand protection	1
72	14.04.02	Handschutzhülse	hand protection	1
73	14.04.02	Handschutzhülse	hand protection	1
74	14.04.02	Handschutzhülse	hand protection	1
75	14.04.02	Handschutzhülse	hand protection	1
76	14.04.02	Handschutzhülse	hand protection	1
77	14.04.02	Handschutzhülse	hand protection	1
78	14.04.02	Handschutzhülse	hand protection	1
79	14.04.02	Handschutzhülse	hand protection	1
80	14.04.02	Handschutzhülse	hand protection	1

81	14.04.02	Handschutzhülse	hand protection	1
82	14.04.02	Handschutzhülse	hand protection	1
83	14.04.02	Handschutzhülse	hand protection	1
84	14.04.02	Handschutzhülse	hand protection	1
85	14.04.02	Handschutzhülse	hand protection	1
86	14.04.02	Handschutzhülse	hand protection	1
87	14.04.02	Handschutzhülse	hand protection	1
88	14.04.02	Handschutzhülse	hand protection	1
89	14.04.02	Handschutzhülse	hand protection	1
90	14.04.02	Handschutzhülse	hand protection	1

91	14.04.02	Handschutzhülse	hand protection	1
92	14.04.02	Handschutzhülse	hand protection	1
93	14.04.02	Handschutzhülse	hand protection	1
94	14.04.02	Handschutzhülse	hand protection	1
95	14.04.02	Handschutzhülse	hand protection	1
96	14.04.02	Handschutzhülse	hand protection	1
97	14.04.02	Handschutzhülse	hand protection	1
98	14.04.02	Handschutzhülse	hand protection	1
99	14.04.02	Handschutzhülse	hand protection	1
100	14.04.02	Handschutzhülse	hand protection	1

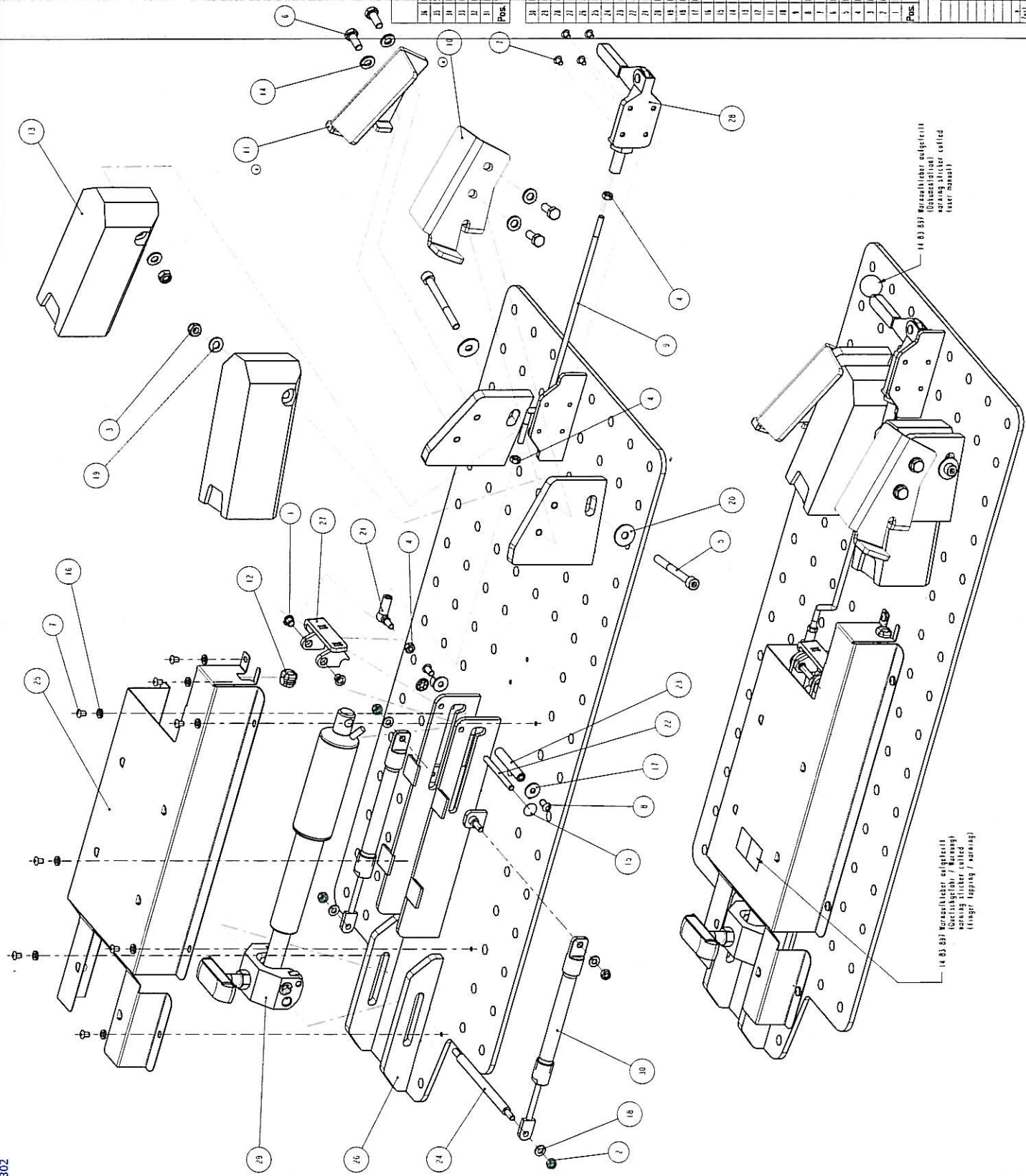

(14.03.93) Korrosionserregend  
 (Batteriezellen)  
 warning sticker called  
 (last manual)

(14.03.93) Korrosionserregend  
 (Batteriezellen)  
 warning sticker called  
 (last manual)

(14.03.93) Korrosionserregend  
 (Batteriezellen)  
 warning sticker called  
 (last manual)

15 10 997  
 15 10 997  
 15 10 997

INVACARE DEUTSCHLAND GMBH

